

File-sharing Onweb with Realistic Tailorable Security (**FORTS**)

Ben Shneiderman

August 3, 2005

File-sharing Onweb with Realistic Tailorable Security (FORTS)



Objects

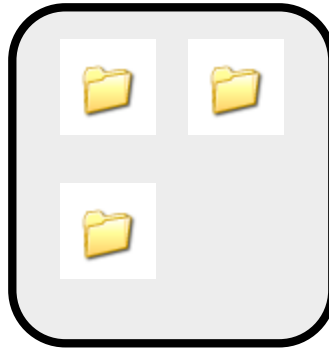

Level 0: Stand alone PC with files only
Personally secured, but inaccessible

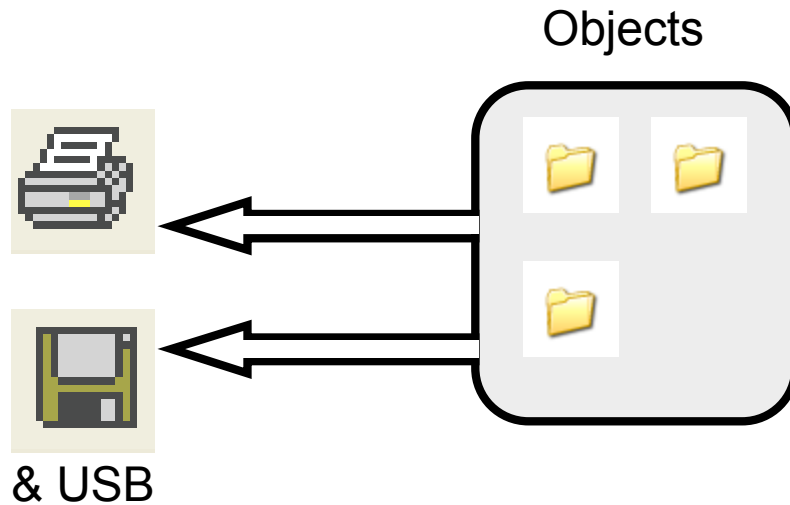

Level 1: Stand alone PC with files, local printer, local disks, no input

Personally secured, but limited access

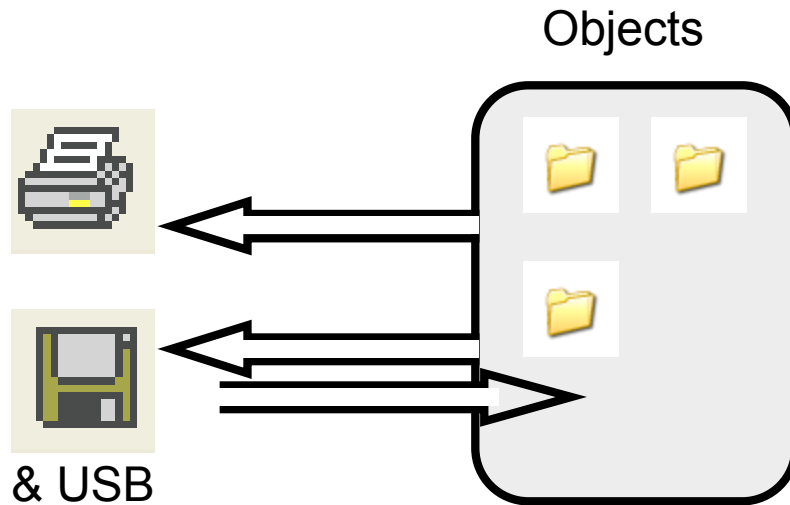

Level 2: Stand alone PC with files, local printer, local disks, two way

Personally secured, but limited access

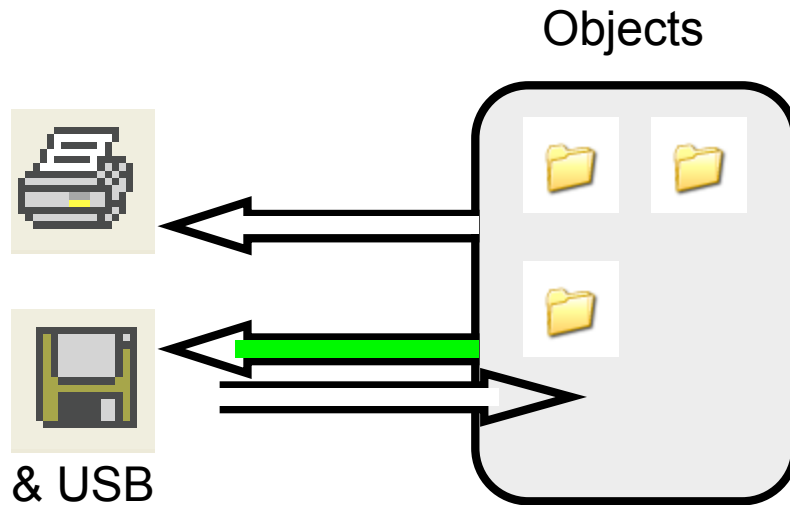

Level 2: Stand alone PC with files, local printer, local disks, two way

Personally secured, but limited access

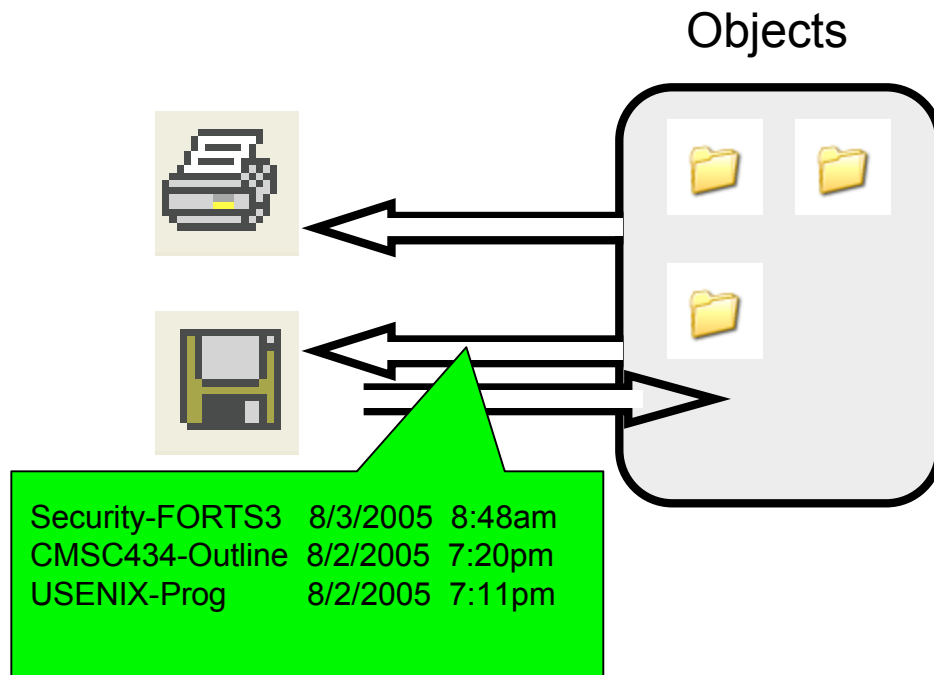

Level 2: Stand alone PC with files, local printer, local disks, two way

Personally secured, but limited access

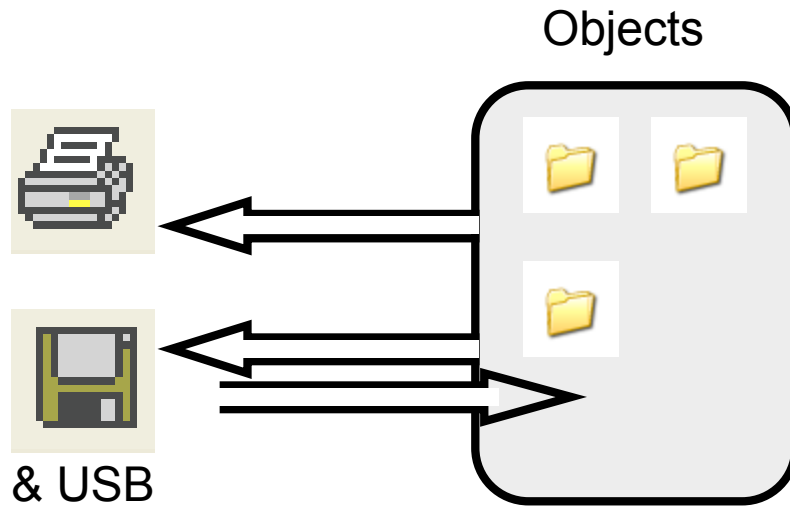

Level 2: Stand alone PC with files, local printer, local disks, two way

Personally secured, but limited access

Actors

<u>Name</u>	<u>Entity</u>	<u>Read</u>	<u>Write</u>	<u>Append</u>	<u>Modify</u>
Sue	Person	x	x	x	x
Western	Group	x			

Objects

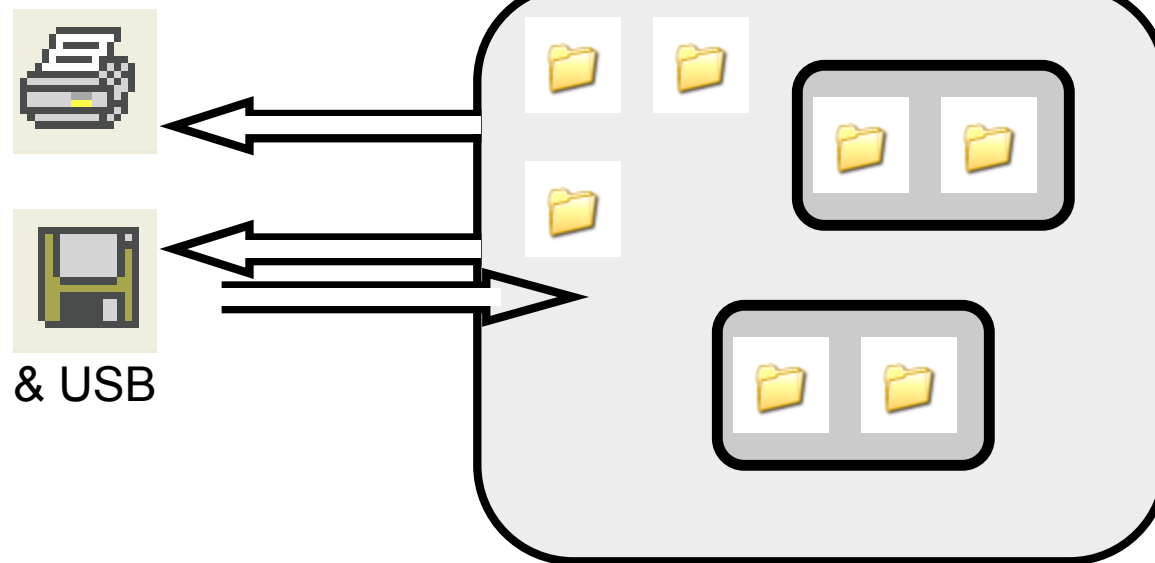

Level 3: Stand alone PC with files, local printer, local disks, two way

Multiple persons & groups given access to some folders, higher protection inside interior walls

Actors

<u>Name</u>	<u>Entity</u>	<u>Read</u>	<u>Write</u>	<u>Append</u>	<u>Modify</u>
Sue	Person	x	x	x	x
Western	Group	x			

Objects

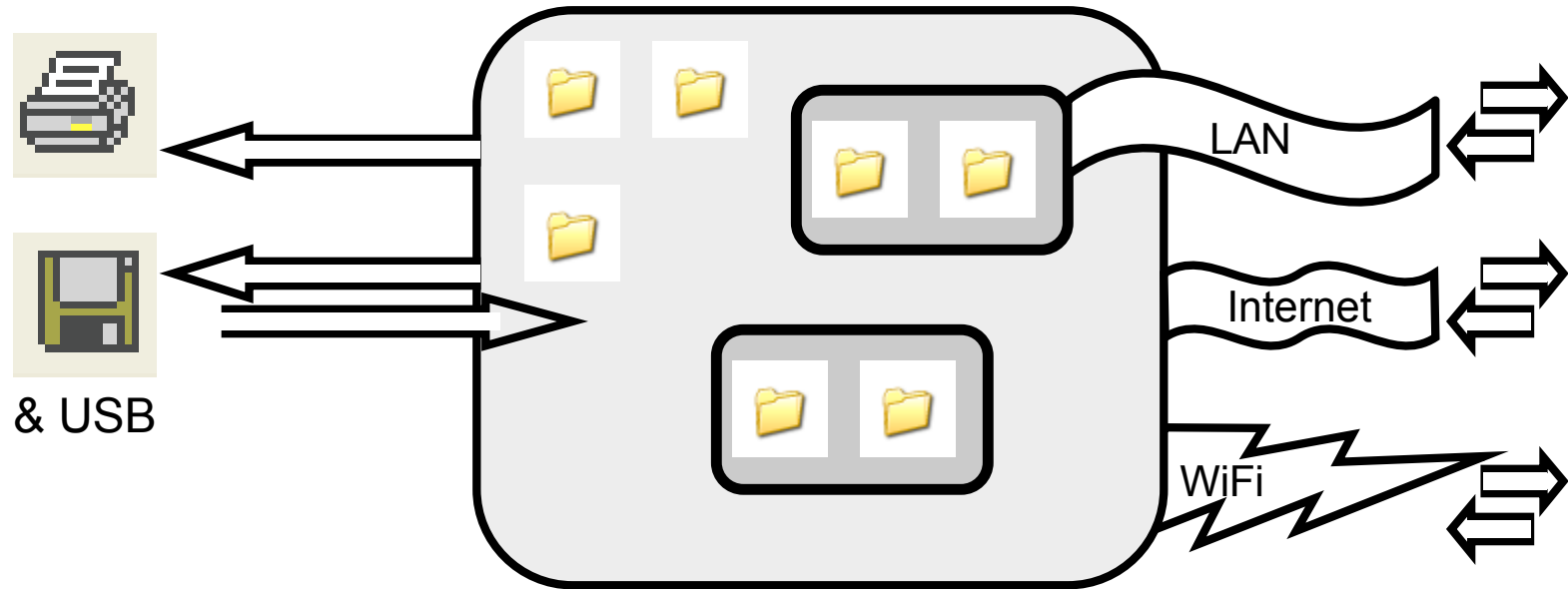

Level 4: Networked PC with files, local printer, local disks, two way

Access to outside world by LAN, Internet, WiFi, etc.

Actors

Name	Entity	Read	Write	Append	Modify
Sue	Person	x	x	x	x
Western	Group	x			

Objects

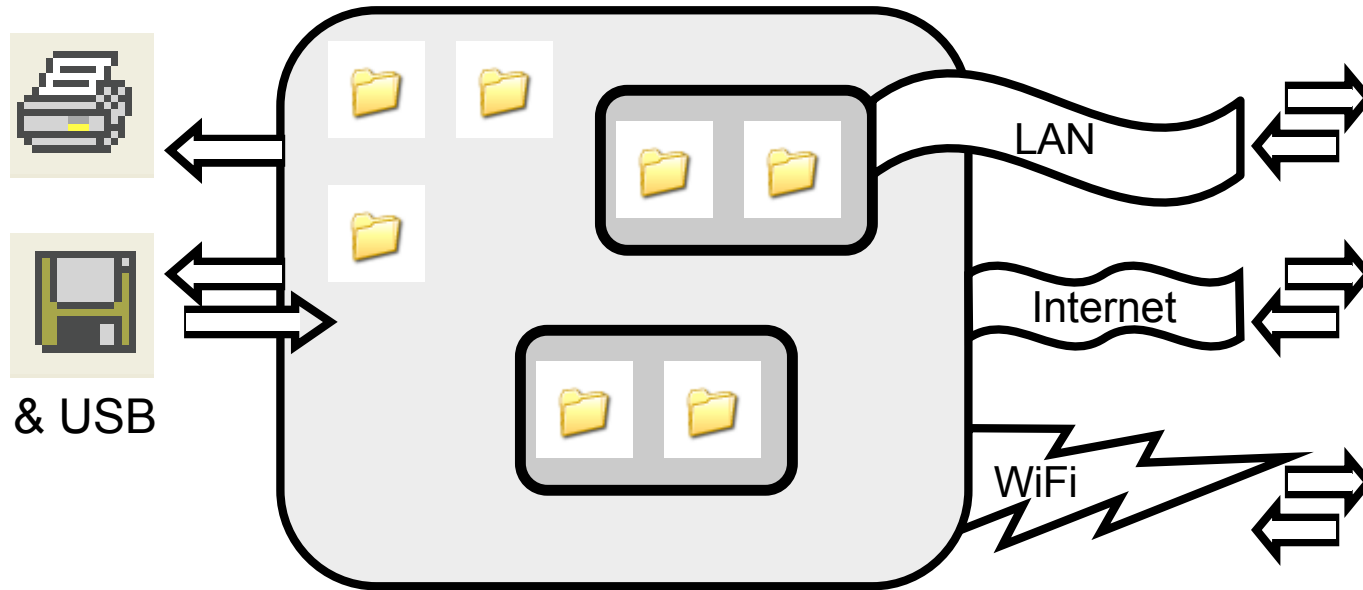

Level 4: Networked PC with files, local printer, local disks, two way

Access to outside world by LAN, Internet, WiFi, etc. for specified actions

Actors

Name	Entity	Read	Write	Append	Modify
Sue	Person	x	x	x	x
Western	Group	x			

Objects

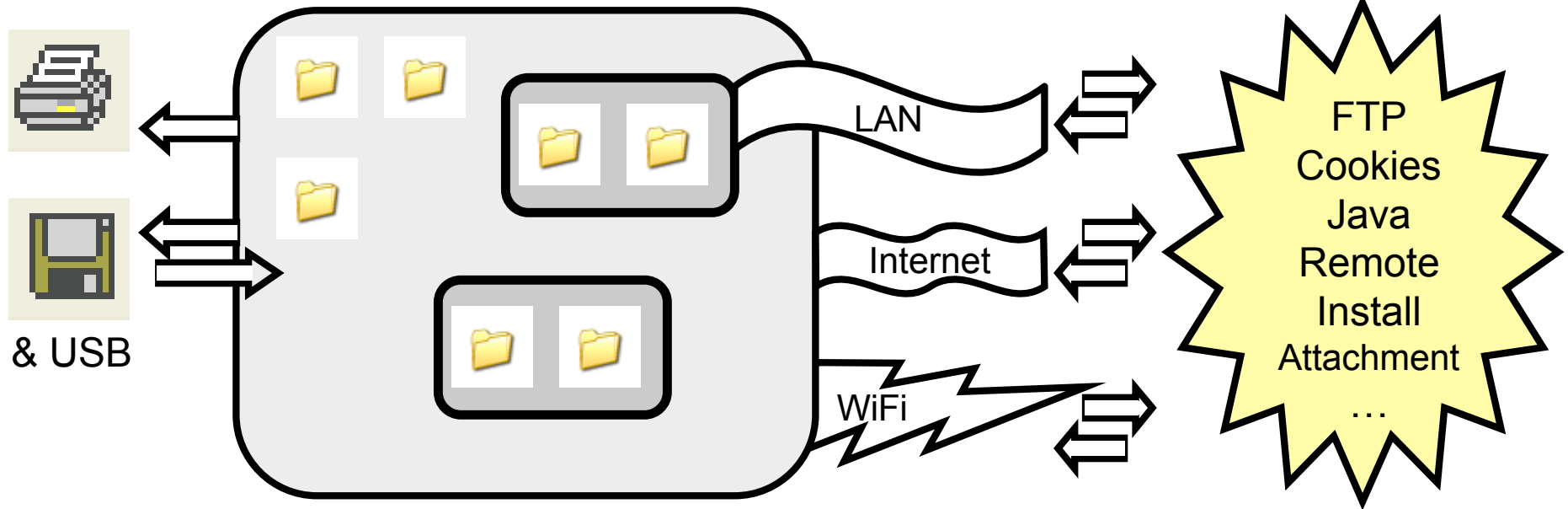

Level 4: Networked PC with files, local printer, local disks, two way

Access to outside world by LAN, Internet, WiFi, etc. for specified actions

Actors

Name	Entity	Read	Write	Append	Modify
Sue	Person	x	x	x	x
Western	Group	x			

Objects

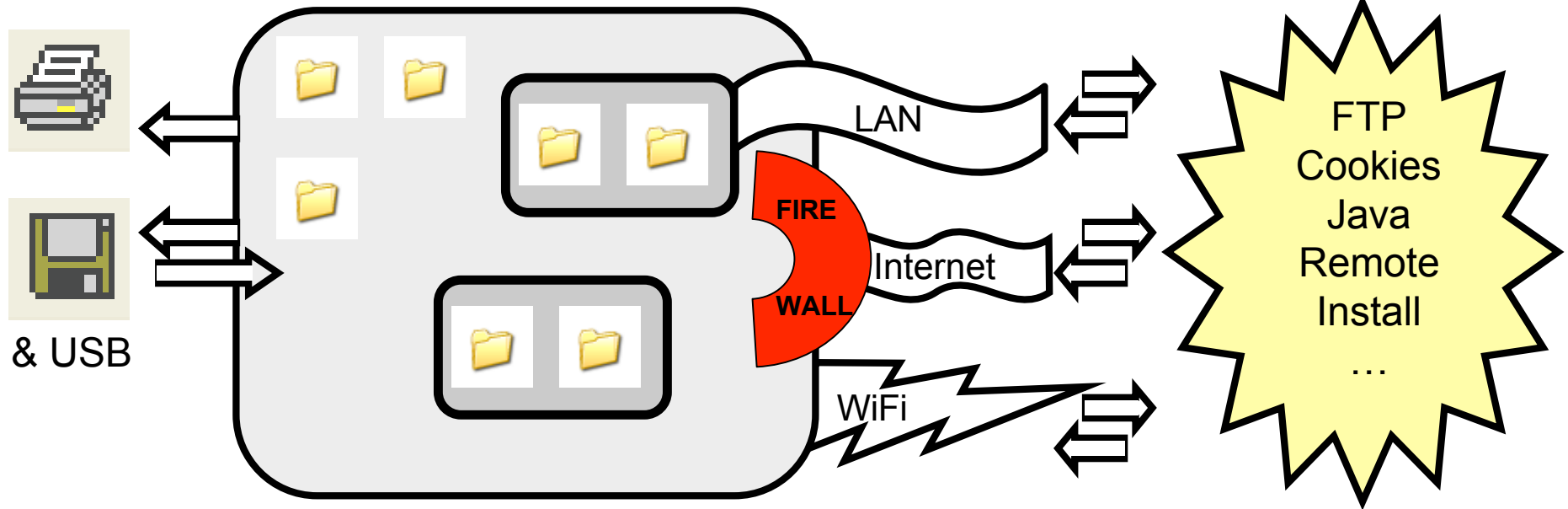

Level 5: Networked PC with files, local printer, local disks, two way

Access to outside world by LAN, Internet, WiFi, etc. for specified actions. Firewall for protection

Actors

Name	Entity	Read	Write	Append	Modify
Sue	Person	x	x	x	x
Western	Group	x			

Objects

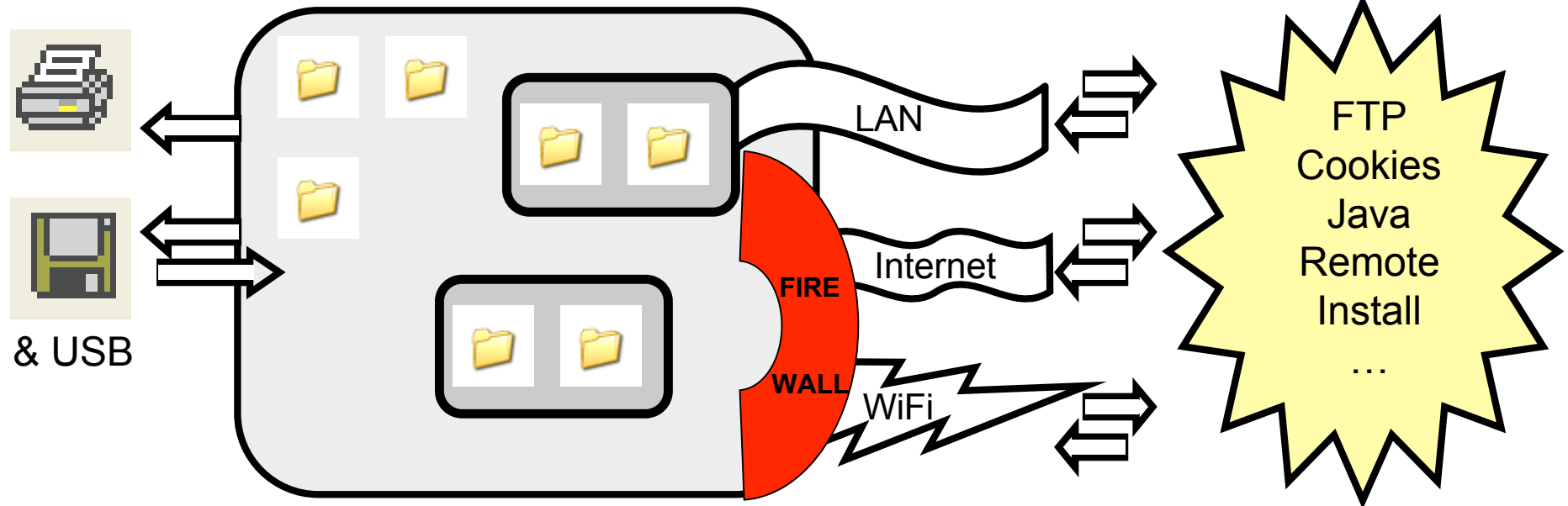

Level 5: Networked PC with files, local printer, local disks, two way

Access to outside world by LAN, Internet, WiFi, etc. for specified actions. Firewall for protection

Actors

Name	Entity	Read	Write	Append	Modify
Sue	Person	x	x	x	x
Western	Group	x			

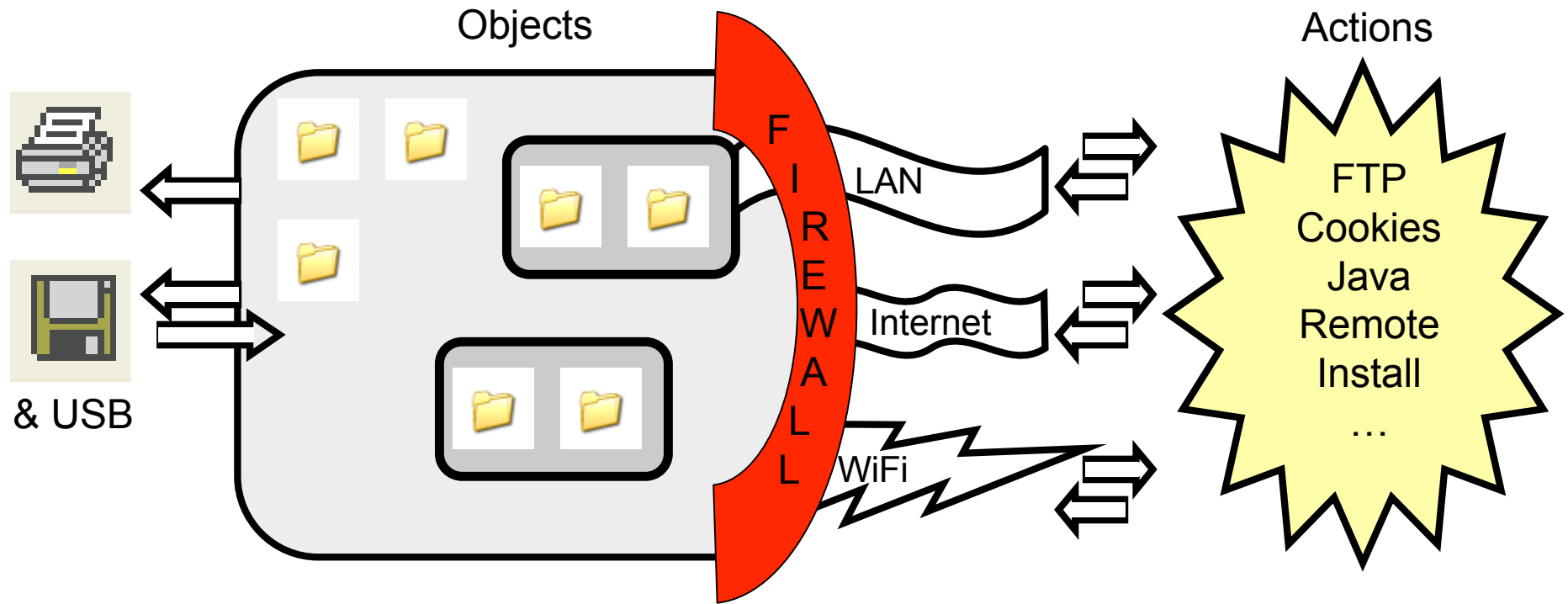

Level 5: Networked PC with files, local printer, local disks, two way

Access to outside world by LAN, Internet, WiFi, etc. for specified actions. Firewall for protection

Actors

Name	Entity	Read	Write	Append	Modify
Sue	Person	x	x	x	x
Western	Group	x			

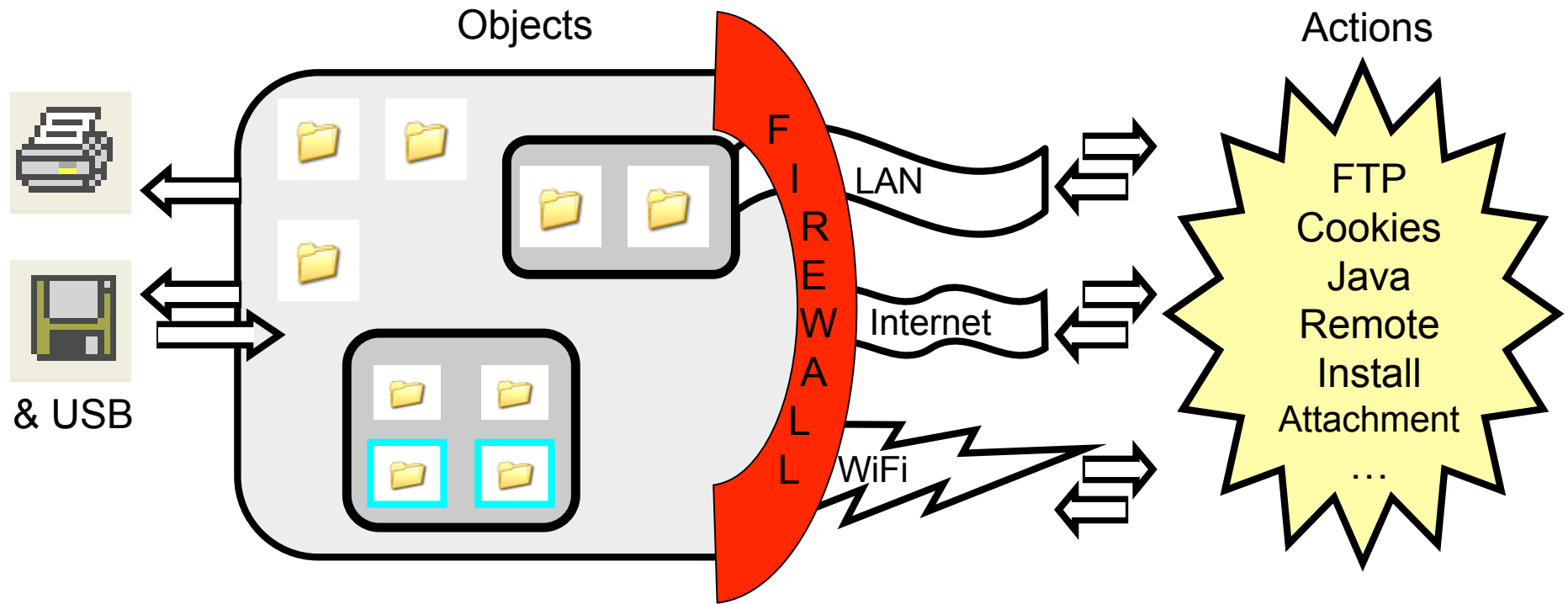

Level 7: Networked PC with files, local printer, local disks, two way

Access to outside world by LAN, Internet, WiFi, etc. for specified actions. Firewall for protection

Actors

Name	Entity	Read	Write	Append	Modify
Sue	Person	x	x	x	x
Western	Group	x			

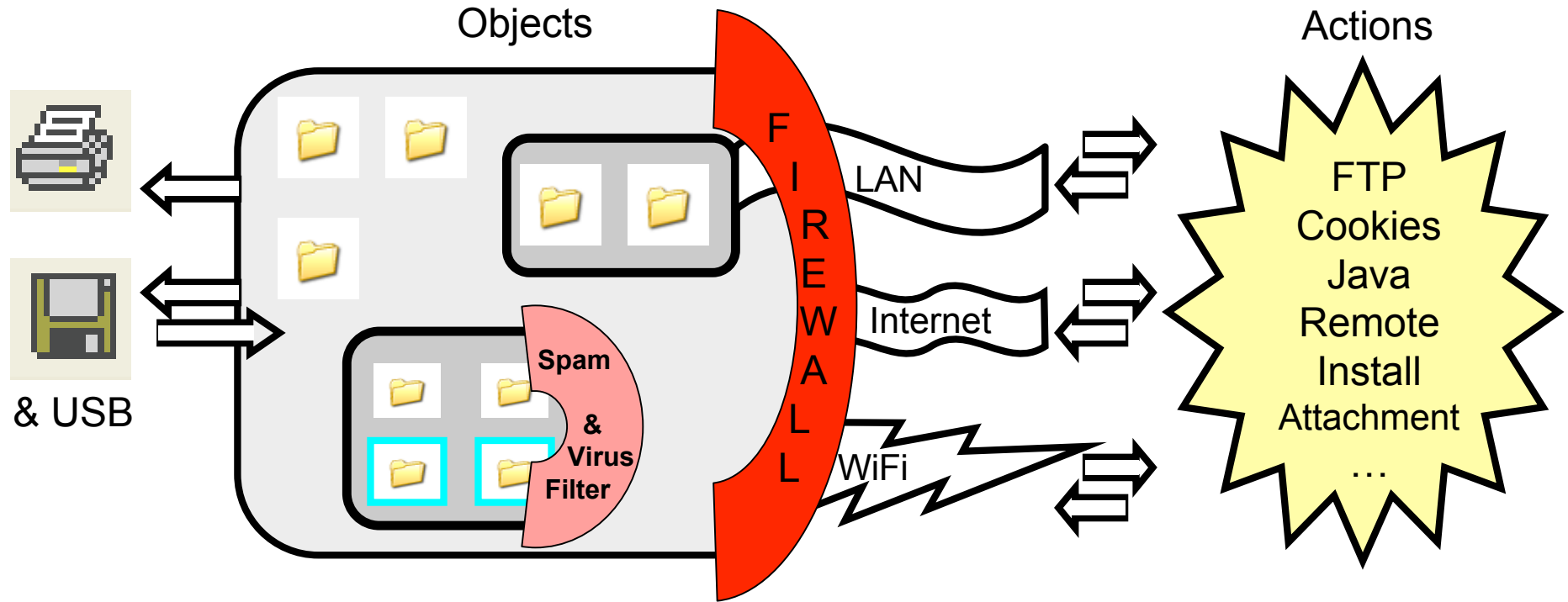

Level 7: Networked PC with files, local printer, local disks, two way

Access to outside world by LAN, Internet, WiFi, etc. for specified actions. Firewall for protection

File-sharing Onweb with Realistic Tailorable Security (**FORTS**)

Ben Shneiderman

August 3, 2005